



PARTYBOX 110



OWNER'S MANUAL

IMPORTANT SAFETY INSTRUCTIONS

For all products:

1. Read these instructions.
2. Keep these instructions.
3. Heed all warnings.
4. Follow all instructions.
5. Clean only with a dry cloth.
6. Do not block any ventilation openings. Install this apparatus in accordance with the manufacturer's instructions.
7. Do not install this apparatus near any heat sources such as radiators, heat registers, stoves or other apparatus (including amplifiers) that produce heat.
8. Do not defeat the safety purpose of the polarized or grounding-type plug. A polarized plug has two blades with one wider than the other. A grounding-type plug has two blades and a third grounding prong. The wide blade or the third prong is provided for your safety. If the provided plug does not fit into your outlet, consult an electrician for replacement of the obsolete outlet.
9. Protect the power cord from being walked on or pinched, particularly at plugs, convenience receptacles and the point where they exit from the apparatus.
10. Use only attachments/accessories specified by the manufacturer.
11. Use only with the cart, stand, tripod, bracket or table specified by the manufacturer or sold with the apparatus. When a cart is used, use caution when moving the cart/apparatus combination to avoid injury from tip-over.
12. Unplug this apparatus during lightning storms or when unused for long periods of time.
13. Refer all servicing to qualified service personnel. Servicing is required when the apparatus has been damaged in any way, such as when the power-supply cord or plug is damaged, liquid has been spilled or objects have fallen into the apparatus, or the apparatus has been exposed to rain or moisture, does not operate normally or has been dropped.
14. To disconnect this apparatus from the AC mains completely, disconnect the power- supply cord plug from the AC receptacle.
15. The mains plug of the power-supply cord shall remain readily operable.
16. This apparatus is intended to be used only with the power supply and/or charging cable provided by the manufacturer.



The following instructions may not apply to waterproof devices. Refer to your device user manual or quick start guide for more waterproof instruction if any.

- Do not use this apparatus near water.
- Do not expose this apparatus to dripping or splashing, and ensure that no objects filled with liquids, such as vases, are placed on the apparatus.

WARNING: To reduce the risk of fire or electric shock, do not expose this apparatus to rain or moisture.

CAUTION

RISK OF ELECTRIC SHOCK. DO NOT OPEN.



THIS SYMBOL ON THE PRODUCT MEANS THERE IS UNINSULATED, DANGEROUS VOLTAGE WITHIN THE PRODUCT ENCLOSURE THAT MAY PRESENT A RISK OF ELECTRICAL SHOCK.



THIS SYMBOL ON THE PRODUCT MEANS THERE ARE IMPORTANT OPERATING AND MAINTENANCE INSTRUCTIONS IN THIS GUIDE.

CAUTION FCC AND IC STATEMENT FOR USERS (USA AND CANADA ONLY)

This device complies with part 15 of the FCC Rules. Operation is subject to the following two conditions: (1) This device may not cause harmful interference, and (2) this device must accept any interference received, including interference that may cause undesired operation.

CAN ICES-003(B)/NMB-003(B)

FCC SDOC SUPPLIER'S DECLARATION OF CONFORMITY

HARMAN International hereby declares that this equipment is in compliance with the FCC Part 15 Subpart B.

The declaration of conformity may be consulted in the support section of our Web site, accessible from www.jbl.com

Federal Communication Commission Interference Statement

This equipment has been tested and found to comply with the limits for a Class B digital device, pursuant to Part 15 of the FCC Rules. These limits are designed to provide reasonable protection against harmful interference in a residential installation. This equipment generates, uses and can radiate radio frequency energy and, if not installed and used in accordance with the instructions, may cause harmful interference to radio communications. However, there is no guarantee that interference will not occur in a particular installation. If this equipment does cause harmful interference to radio or television reception, which can be determined by turning the equipment off and on, the user is encouraged to try to correct the interference by one or more of the following measures:

- Reorient or relocate the receiving antenna.
- Increase the separation between the equipment and receiver.
- Connect the equipment into an outlet on a circuit different from that to which the receiver is connected.
- Consult the dealer or an experienced radio/TV technician for help.

CAUTION: Changes or modifications not expressly approved by HARMAN could void the user's authority to operate the equipment.

For Products That Transmit RF Energy:

(i) FCC AND IC INFORMATION FOR USERS

This device complies with Part 15 of the FCC rules and Industry Canada license-exempt RSS standard(s). Operation is subject to the following two conditions: (1) This device may not cause

harmful interference; and (2) this device must accept any interference received, including interference that may cause undesired operation.

(ii) FCC/IC Radiation Exposure Statement

This equipment complies with FCC and ICED radiation exposure limits set forth for an uncontrolled environment.

In case this equipment has to subject to FCC/IC SAR (Specific Absorption Rate) exposure test, this equipment is designed to meet the requirements for exposure to radio waves established by the FCC and ICED. These requirements set a SAR limit of 1.6 W/kg averaged over one gram of tissue. The highest SAR value reported under this standard during product certification for use when properly worn on the body or on the head, with no separation. To meet RF exposure guidelines and reduce exposure to RF energy during the operation, this equipment should be positioned at least this distance away from the body or the head.

For radio equipment operates in 5150-5850MHz

FCC and IC Caution:

High power radars are allocated as primary users of the 5.25 to 5.35 GHz and 5.65 to 5.85 GHz bands. These radar stations can cause interference with and/or damage to LE LAN (Licence-Exempt Local Area Network) devices. No configuration controls are provided for this wireless equipment allowing any change in the frequency of operations outside the FCC grant of authorization for US operation according to Part 15.407 of the FCC rules.

IC Caution:

User should also be advised that:

- (i) The device for operation in the band 5150 - 5250 MHz is only for indoor use to reduce the potential for harmful interference to co-channel mobile satellite systems; (ii) the maximum antenna gain permitted for devices in the bands 5250 - 5350 MHz and 5470 - 5725 MHz shall comply with the e.i.r.p. limit: and
- (ii) The maximum antenna gain permitted for devices in the band 5725 - 5825 MHz shall comply with the e.i.r.p. limits specified for point-to-point and non point-to-point operation as appropriate.

Use Restriction Attention in European Union, operation is limited to indoor use within the band 5150-5350 MHz.

Correct disposal of this product (Waste Electrical & Electronic Equipment)



This symbol means the product must not be discarded as household waste, and should be delivered to an appropriate collection facility for recycling. Proper disposal and recycling helps protect natural resources, human health and the environment. For more information on disposal and recycling of this product, contact your local municipality, disposal service, or the shop where you bought this product.

This product is RoHS compliant.

This product is in compliance with Directive 2011/65/EU, and its amendments, on the restriction of the use of certain hazardous substances in electrical and electronic equipment.

REACH

REACH (Regulation No 1907/2006) addresses the production and use of chemical substances and their potential impacts on human health and the environment. Article 33(1) of REACH Regulation requires suppliers to inform the recipients if an article contains more than 0.1 % (per weight per article) of any substance(s) on the Substances of Very High Concern (SVHC) Candidate List ('REACH candidate list'). This product contains the substance "lead"(CAS-No. 7439-92-1) in a concentration of more than 0.1% per weight.

At the time of release of this product, except for the lead substance, no other substances of REACH candidate list are contained in a concentration of more than 0.1% per weight in this product.

Note: On June 27, 2018, lead was added to the REACH candidate list. The inclusion of lead in the REACH candidate list does not mean that lead-containing materials pose an immediate risk or results in a restriction of permissibility of its use.

For devices with headphone jacks

WARNINGS/CAUTIONS



Do NOT use the headphones at a high volume for any extended period.

- To avoid hearing damage, use your headphones at a comfortable, moderate volume level.
- Turn the volume down on your device before placing the headphones on your ears, then turn the volume up gradually until you reach a comfortable listening level.

For Products That Include Batteries

Instructions for Users on Removal, Recycling and Disposal of Used Batteries

To remove the batteries from your equipment or remote control, reverse the procedure described in the owner's manual for inserting batteries. For products with a built-in battery that lasts for the lifetime of the product, removal may not be possible for the user. In this case, recycling or recovery centers handle the dismantling of the product and the removal of the battery. If, for any reason, it becomes necessary to replace such a battery, this procedure must be performed by authorized service centers. In the European Union and other locations, it is illegal to dispose of any battery with household trash. All batteries must be disposed of in an environmentally sound manner. Contact your local waste-management officials for information regarding the environmentally sound collection, recycling and disposal of used batteries.

WARNING: Danger of explosion if battery is incorrectly replaced. To reduce risk of fire, explosion or leakage of flammable liquid/gas, don't disassemble, crush, puncture, short external contacts, expose to temperature above 60°C (140°F), sunshine or like, expose to extremely low air pressure or dispose of in fire or water.

Replace only with specified batteries. The symbol indicating 'separate collection' for all batteries and accumulators shall be the crossed-out wheeled bin shown below:



WARNING - For Products Contain Coin/Button Cell Batteries

DO NOT INGEST BATTERY, CHEMICAL BURN HAZARD. This product contains a coin/button cell battery. If the coin/button cell battery is swallowed, it can cause severe internal burns in just 2 hours and can lead to death. Keep new and used batteries away from children. If the battery compartment does not close securely, stop using the product and keep it away from children. If you think batteries might have been swallowed or placed inside any part of the body, seek immediate medical attention.

For All Products with Wireless Operation:

HARMAN International hereby declares that this equipment is in compliance with the essential requirements and other relevant provisions of Directive 2014/53/EU and UK Radio Equipment Regulations 2017. The declaration of conformity may be consulted in the support section of our Web site, accessible from www.jbl.com.

EPILEPSY WARNING

A few people may experience epileptic seizures when viewing flashing lights.

Precautions

Stand Mounting Safety Precautions

Always follow instruction and precaution advice from speaker stand manufacturer.

This speaker contains a 36 mm receptacle cup to allow mounting on tripod stands or on a pole over subwoofers. When using stands or poles, be sure to observe the following precautions:

- Check the stand or pole specification to be certain the device is designed to support the weight of the speaker. Observe all safety precautions specified by the manufacturer.
- Always verify that the stand (or subwoofer/pole) is placed on a flat, level and stable surface and be sure to fully extend the legs of tripod type stands. Position the stand so that the legs do not present a trip hazard.
- Use this floor stand only on a flat, solid surface. Once the support (extended leg) has been placed and adjusted, carefully tighten the screws and use the safety pin. After placing the speaker on the stand, check for stability: When tilting each direction to 10 degrees (for the surface), the speaker should not turn off. If necessary, reduce the height of the speakers and extend the base of the stand.
- Route cables so that performers, production crew, and audience will not trip and topple the speakers over.
- Inspect the stand (or pole and associated hardware) before each use and do not use equipment with worn, damaged or missing parts.
- Do not attempt to place more than one PartyBox series speaker on a stand or pole.
- Always be cautious in windy, outdoor conditions. It may be necessary to place additional weight (i.e. sandbags) on the base of the stand to improve stability. Avoid attaching banners or similar items to any part of a speaker system. Such attachments could act as a sail and topple the system.
- Unless you are confident that you can handle the weight of the speaker, ask another person to help you get it onto the tripod stand or pole.

TABLE OF CONTENTS

IMPORTANT SAFETY INSTRUCTIONS 2

1. INTRODUCTION 6

2. WHAT'S IN THE BOX 6

3. PRODUCT OVERVIEW 7

- 3.1 TOP PANEL 7
 - 3.2 BACK PANEL 7
-

4. PLACEMENT 8

5. POWER ON 9

6. USING YOUR PARTYBOX 9

- 6.1 BLUETOOTH CONNECTION 9
 - 6.2 USB CONNECTION 10
 - 6.3 MUSIC CONTROL 10
 - 6.4 AUX CONNECTION 10
 - 6.5 MIXING SOUND WITH A MICROPHONE AND /
OR GUITAR 11
 - 6.6 CHARGING YOUR MOBILE DEVICE 11
-

7. CARRYING YOUR PARTYBOX 12

8. POLE-MOUNTING YOUR PARTYBOX 12

9. ADVANCED USAGE 13

- 9.1 JBL PARTYBOX APP 13
 - 9.2 LIGHT EFFECT 13
 - 9.3 TWS MODE 13
 - 9.4 DAISY CHAIN 13
 - 9.5 FACTORY RESET 13
 - 9.6 IPX4 14
-

10. SPECIFICATIONS 14

11. TROUBLESHOOTING 15

12. COMPLIANCE 15

13. TRADEMARK 16

1. INTRODUCTION

Congratulations on your purchase! This manual includes information about **PARTYBOX 110** speakers. We encourage you to take a few minutes to read this manual, which describes the product and includes step-by-step instructions to help you to set up and get started. Read and understand all the safety instructions before using your product.

If you have any questions about these products, their installation or their operation, please contact your retailer or customer service, or visit us at www.jbl.com.

2. WHAT'S IN THE BOX

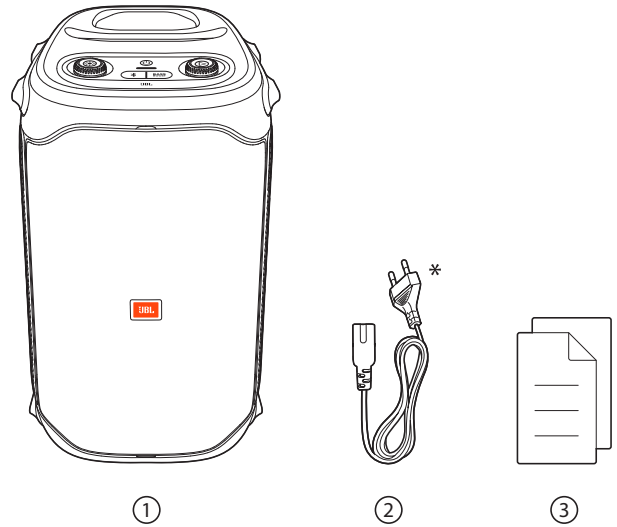

- 1) Main unit
- 2) Power cord*
- 3) Quick Start Guide, Safety Sheet, Warranty Card

*Power cord quantity and plug type vary by regions.

3. PRODUCT OVERVIEW

3.1 Top Panel

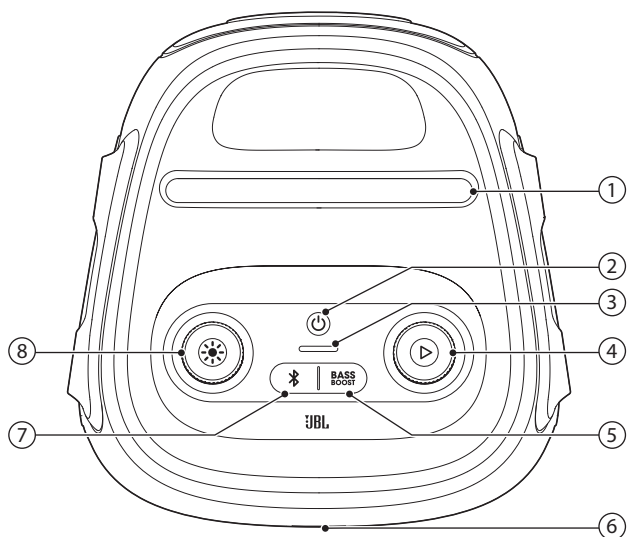

1) Mobile device dock

- 2) 
- Turn the power on or off.

3) Battery level indicator

- 4) 
- Press to play, pause or resume.
 - Rotate clockwise / counterclockwise to increase / decrease the main volume.

5) **BASS BOOST**

- Enhances the bass level: level 1, level 2, or off.

6) LED ring















- 7) 
- Press to enter Bluetooth pairing mode.
 - Press and hold for more than 10 seconds to forget all paired devices.

- 8) 
- Rotate clockwise / counterclockwise to switch between different light patterns.
 - Press to turn light effect on or off.
 - Hold for more than 2 seconds to turn strobe light on or off.

Caution:

- Do not look directly at the light-emitting parts when the speaker lights are turned on.

LED behavior

		Power on
		Standby / Power off
		Pairing
		Connected
		Not connected
BASS BOOST		Level 1
		Level 2
		Off
		Low battery
		Charging
		The speaker is fully charged when the entire light stripe turns solid white.

3.2 Back Panel

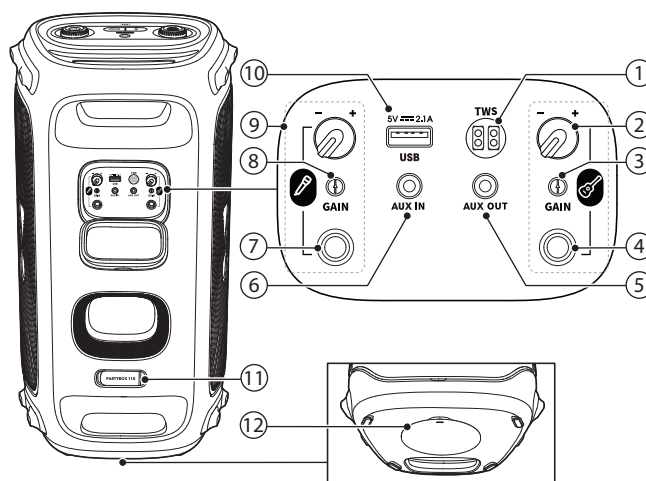

1) TWS

- Press to enter True Wireless Stereo (TWS) pairing mode.

2) Guitar volume

- Adjust volume of the connected guitar.

3) GAIN (guitar)

- Adjust gain of the connected guitar.

4) Guitar socket

- Connect to a guitar.

5) AUX OUT

- Daisy-chain PARTYBOX speakers through 3.5 mm audio cables (not supplied).

6) AUX IN

- Connect to an external audio device through a 3.5 mm audio cable (not supplied).
- Daisy-chain PARTYBOX speakers through 3.5 mm audio cables (not supplied).

7) Microphone socket

- Connect to a microphone.

8) GAIN (microphone)

- Adjust gain of the connected microphone.

9) Microphone volume

- Adjust volume of the connected microphone.

10) USB

- Connect to a USB storage device.
- Charge your mobile device.

11) AC

- Connect to AC power supply.

12) Pole-mounting your PARTYBOX

4. PLACEMENT

Caution:

- Do not sit or lean on the speaker or push it sideways to avoid tip-over and possible damages.

Place the speaker on a flat, stable surface and ensure that the rubber feet side is down.

5. POWER ON

Cautions:

- Use the provided power cords only.
- You can use either AC power or the built-in battery as power supply to the speaker.

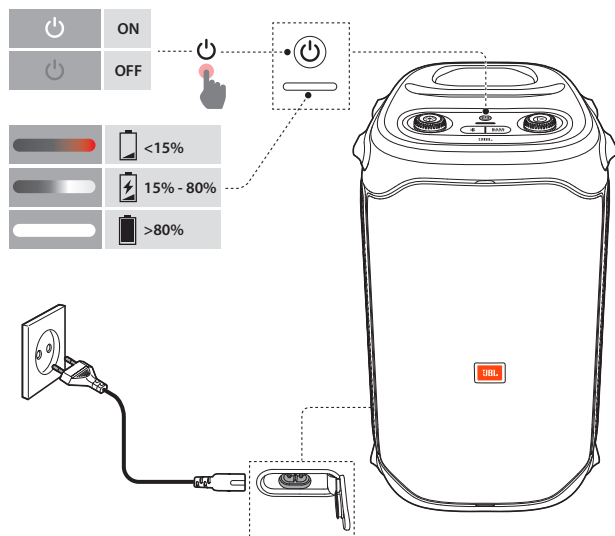

1. Connect AC power.
 - To use the built-in battery, disconnect AC power after charging the speaker.
2. Press to power on.

Tips:

- Fully charge the speaker before first-time use to prolong the lifespan of the built-in battery.
- You can check the battery level by pressing any button on the speaker.
- The speaker switches to standby mode automatically after 20 minutes of inactivity. You can press on the speaker to switch to normal operation.

6. USING YOUR PARTYBOX

Notes:

- Only one sound source can be played at a time. The priority order is USB -> BLUETOOTH -> AUX.
- Starting a source with higher priority will always interrupt a source with lower priority.
- To start a source with lower priority, stop the source with higher priority first.

6.1 Bluetooth Connection

You can use the speaker with your Bluetooth enabled smartphone or tablet.

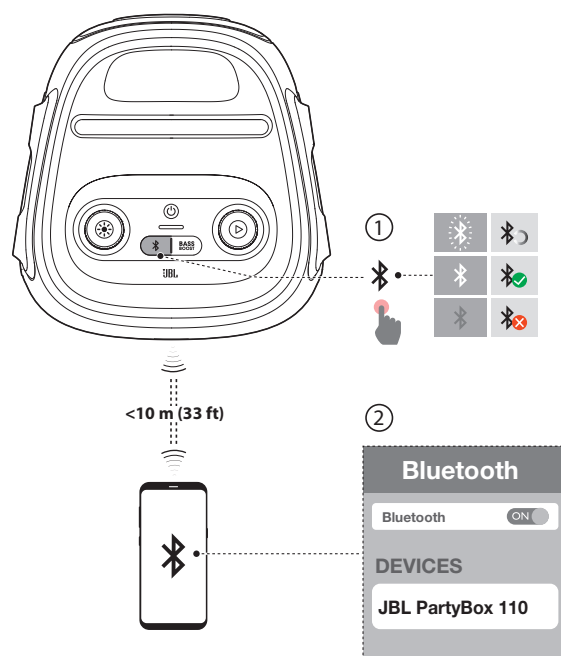

1. Press on the speaker to enter Bluetooth pairing mode.
2. Choose “JBL PartyBox 110” on your Bluetooth device to connect.
3. Once successfully connected, you can stream audio from your Bluetooth device to this speaker.

Notes:

- This speaker can memorize a maximum of 8 paired devices. The ninth paired device will replace the first one.
- Enter “0000” if a PIN code is requested for connection to a Bluetooth device.
- Bluetooth performance can be affected by the distance between this product and your Bluetooth device and the environment of operation.

To terminate the Bluetooth-enabled device:

- Turn off this speaker, or
- Disable Bluetooth on your device.

To reconnect the Bluetooth enabled device:

- When you turn on this speaker next time, it tries to reconnect the last connected device automatically.
- If not, manually select “JBL PartyBox 110” on your Bluetooth device to connect.

6.2 USB Connection

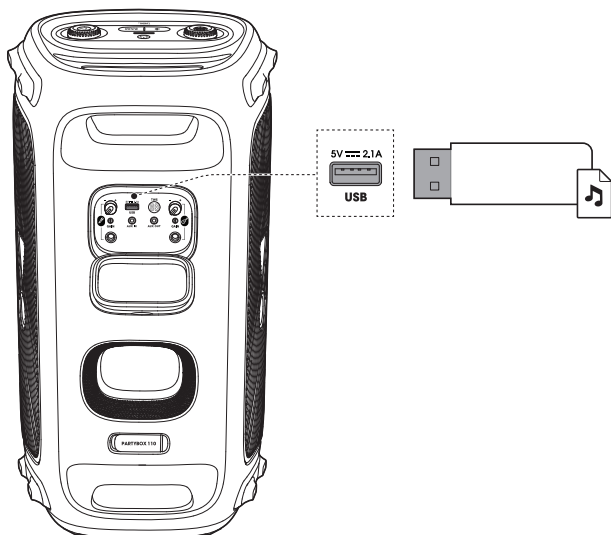

Plug a USB storage device that contains playable audio contents into the USB port of the speaker.

- The speaker switches to the USB source automatically.
- Audio playback will start automatically.

Tip:

- The speaker plays audio files on the USB storage device from the root folder to the last level of subfolders in alphabetical sequence. Up to 8 levels of subfolders are supported.

Supported audio formats

Extension	Codec	Sample rate	Bitrate
WAVE	PCM	8 / 11.025 / 12 / 16 / 22.05 / 24 / 32 / 44.1 / 48	384 / 529.2 / 576 / 768 / 1058.4 / 1152 / 1536 / 2116.8 / 2304
MP3	MPEG1 layer2/3	32 / 44.1 / 48	32 / 40 / 48 / 56 / 64 / 80 / 96 / 112 / 128 / 160 / 192 / 224 / 256 / 320
	MPEG2 layer2/3	16 / 22.05 / 24	8 / 16 / 24 / 32 / 40 / 48 / 56 / 64 / 80 / 96 / 112 / 128 / 144 / 160
	MPEG2.5 layer3	8 / 11.025 / 12	8 / 16 / 24 / 32 / 40 / 48 / 56 / 64 / 80 / 96 / 112 / 128 / 144 / 160
WMA		8 / 11.025 / 16 / 22.05 / 32 / 44.1 / 48	5 / 6 / 8 / 10 / 12 / 16 / 20 / 22 / 32 / 36 / 40 / 44 / 48 / 64 / 80 / 96 / 128 / 160 / 192 / 256 / 320

6.3 Music Control

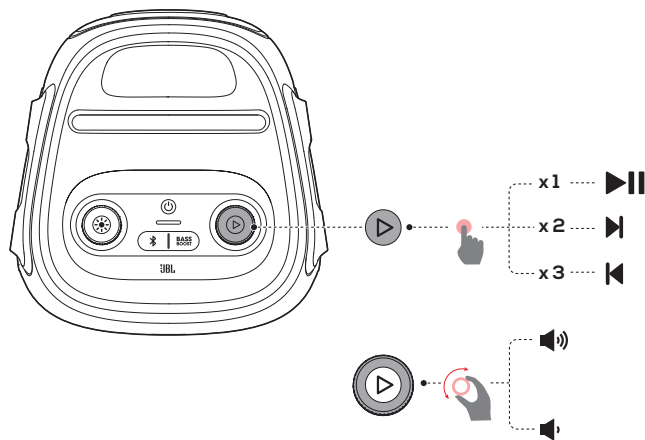

- Press once to pause or resume playback.
- Press twice to skip to the next track.
- Press three times to skip to the previous track.
- Rotate the clockwise / counterclockwise to increase / decrease the main volume.
- Press **BASS BOOST** to enhance the bass level: level 1, level 2, or off.

Note:

- The skip operation is unavailable in AUX mode.

6.4 AUX Connection

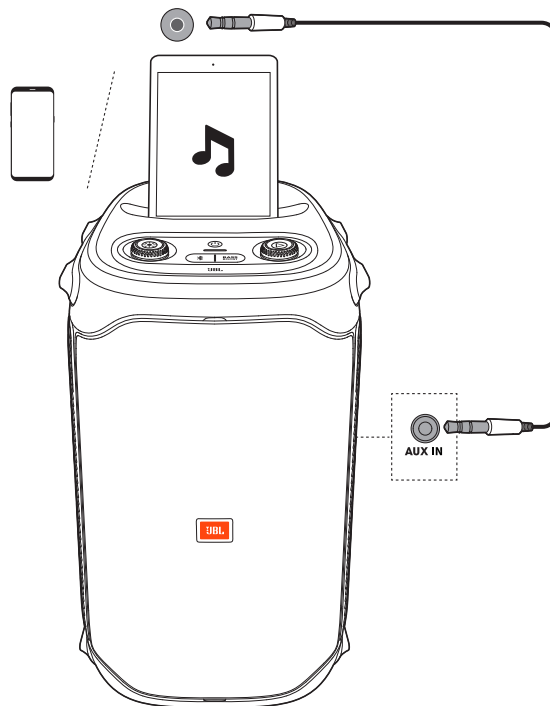

1. Connect an external audio device to the speaker through a 3.5 mm audio cable (not supplied).
2. After stopping playback from any other source, start audio playback on the external device.

6.5 Mixing Sound with a Microphone and / or Guitar

By using a microphone or electric guitar (not supplied), you can mix sound with an audio source.

Notes:

- Always set the guitar or microphone volume to the minimum level before guitar or microphone connection / disconnection.
- Always disconnect the guitar or microphone when you are not using them.

6.5.1 Connecting a Microphone

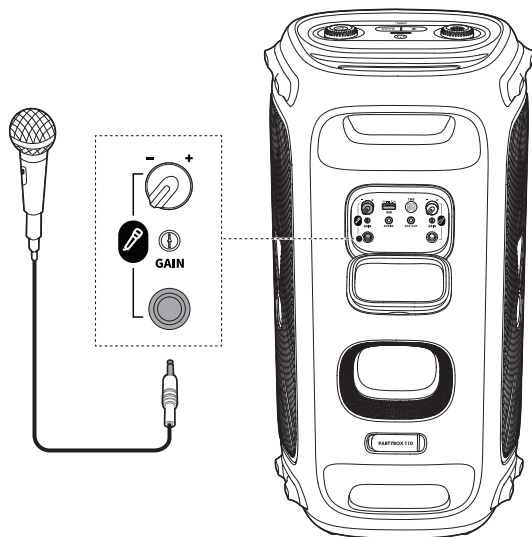

Connect a microphone to the microphone socket.

6.5.2 Connecting a Guitar

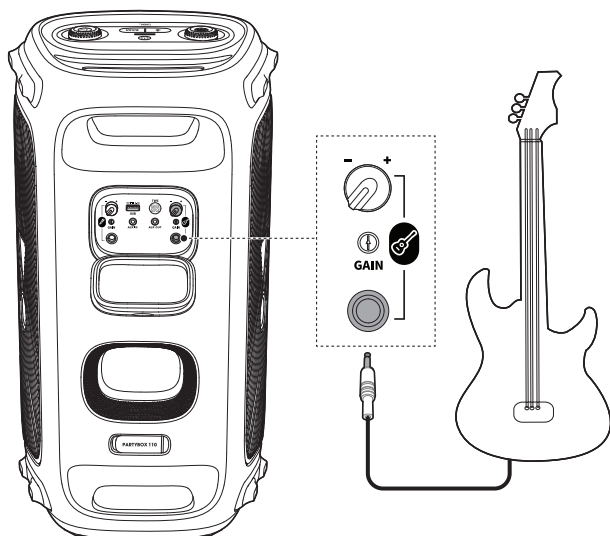

Connect a guitar to the guitar socket.

6.5.3 Mixing Sound

Sing through the microphone or play guitar.

- To adjust the volume of the audio source, rotate the knob clockwise / counterclockwise.
- To adjust the volume of the microphone or guitar, rotate the microphone or guitar volume knob.
- To adjust the gain of the wired microphone or guitar, rotate the **GAIN** control beside the microphone or guitar socket respectively.

6.6 Charging Your Mobile Device

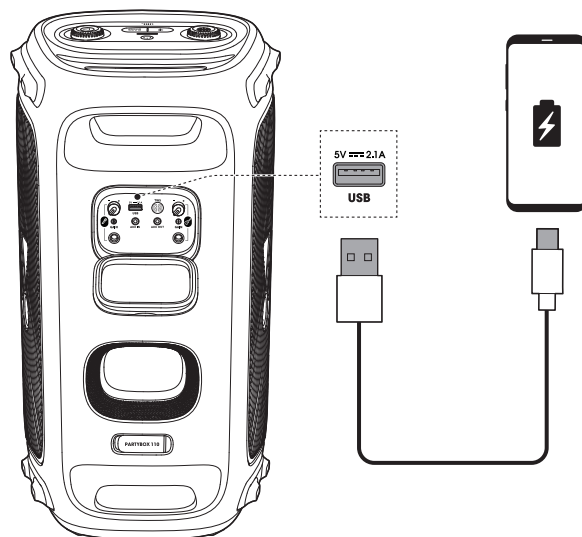

Note:

- The USB port is for charging purpose only.

7. CARRYING YOUR PARTYBOX

Cautions:

- Before carrying the speaker, ensure that all the cords are disconnected.
- To avoid personal injury and/or property damage, hold the product firmly while carrying.

Hold the handles firmly to carry the speaker.

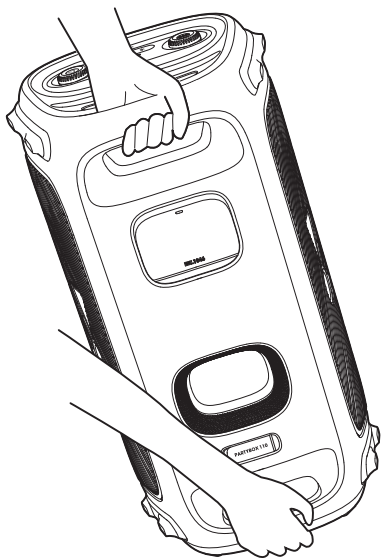

8. POLE-MOUNTING YOUR PARTYBOX

Cautions:

- Installation must be done by qualified persons using safe rigging standards.
- The installer is responsible for proper selection and use of mounting hardware, to properly and safely pole-mount the speakers.

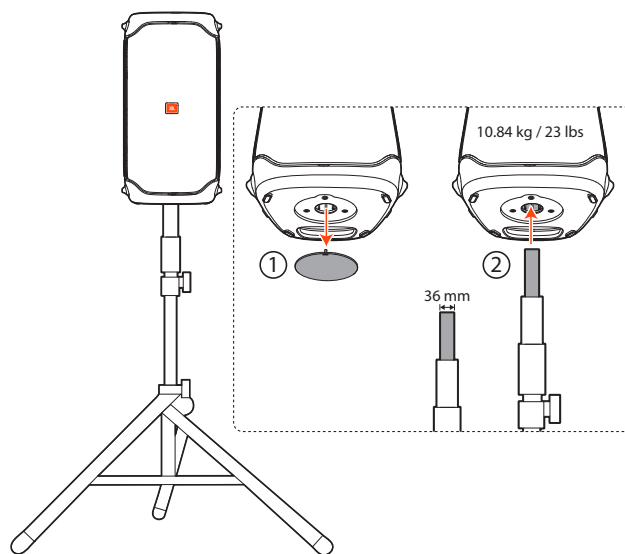

9. ADVANCED USAGE

9.1 JBL PARTYBOX App



Download and install the JBL PARTYBOX App to get more from the product.

9.2 Light Effect



- Press to turn the light effect on or off.
- Hold for more than 2 seconds to turn strobe light on or off.
- Rotate the knob to select your preferred light effect: rock, flow, cross, ripple, or flash.

9.3 TWS Mode

You can connect two PARTYBOX speakers to each other via TWS mode.

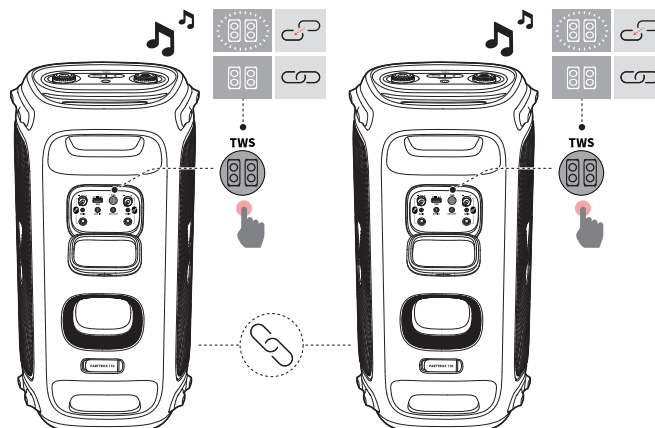

Press **TWS** on both speakers.

To exit TWS mode:

Power off or press **TWS** on either speaker.

Tip:

- By default, the speaker connected to your Bluetooth device acts as the primary speaker (left channel), while the other one acts as the secondary speaker (right channel).

9.4 Daisy Chain

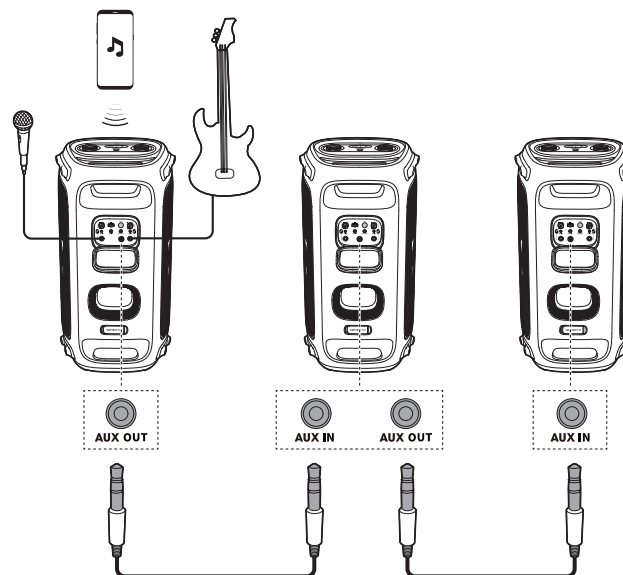

9.5 Factory reset

To restore the factory settings, hold and for more than 10 seconds.

9.6 IPX4

Caution:

- Always keep the charging port dry before connecting AC power.
- To ensure splash resistance, always keep the protective covers closed securely.

The speaker is IPX4 splash resistant.



10. SPECIFICATIONS

General specification

Model No.:	JBL PartyBox 110
Transducers:	2 x 154.6 mm / 5.25" woofer, 2 x 55 mm / 2.25" tweeter
Output power:	160 W RMS
Power input:	100 V - 240 V / 50/60 Hz
Frequency response:	45 Hz - 20 kHz (-6 dB)
Signal-to-noise ratio:	> 80 dB
Battery type:	Li-ion polymer 36 Wh
Battery charge time:	3.5 hours
*Music play time:	Up to 12 hours

USB specification

USB format:	FAT16, FAT32
USB file format:	.mp3, .wma, .wav
USB charge out:	5 V / 2.1 A (maximum)
Cable type:	AC Power Cable
Cable length:	2000 mm / 78.7"

Wireless specification

Bluetooth® version:	5.1
Bluetooth® profile:	A2DP 1.3, AVRCP 1.6
Bluetooth® transmitter frequency range:	2.4 GHz - 2.4835 GHz
Bluetooth® transmitter power:	≤ 15 dBm (EIRP)
Bluetooth® transmitter modulation:	GFSK, π/4 DQPSK, 8DPSK

Dimensions

Dimensions (W x H x D):	295 mm x 568 mm x 300 mm / 11.6" x 22.4" x 11.8"
Weight:	10.84 kg / 23 lbs

* 12 hrs battery playtime is only a reference and may vary depending on music content and battery aging after numerous charging and discharging cycles. It's achievable with a predefined music source, light show switched off, volume level at 7 and Bluetooth streaming source.

11. TROUBLESHOOTING

Caution:





- Never try to repair the product by yourself. If you have any problems while using this product, check the following points before you request service.

System

The speaker will not turn on.

- Ensure that the speaker battery is not drained. If not, use the AC power instead.

No response from some buttons

- The product may be in demo mode. In demo mode, the  and  buttons are disabled. Hold  and  simultaneously for more than 5 seconds to exit.

Sound

No sound from the speaker.

- Ensure that the speaker is powered on.
- Adjust volume.
- Ensure that a sound source is active and not muted.

Bluetooth

A device cannot connect with the speaker.

- Ensure that the Bluetooth function of the device is enabled.
- The speaker is already connected with another Bluetooth device. Hold  on the speaker for more than 10 seconds to disconnect and pair with a new device.

Poor audio quality from a connected Bluetooth device

- The Bluetooth reception is poor. Move the device closer to the speaker, or remove any obstacle between the device and speaker.

12. COMPLIANCE

The product is in compliance with the European Union energy legislation.

Bluetooth connection mode

The product is intended to be used for streaming music via Bluetooth connection. A consumer can stream Bluetooth audio to the speaker. When the product is connected through Bluetooth, the Bluetooth connection must remain active at all times to ensure proper operation.

The product will enter sleep mode (networked standby) after 20 minutes without operation. The power consumption in sleep mode is less than 2.0 Watts, after which it can be re-activated via Bluetooth connection.

Bluetooth disconnection mode

The product will enter standby mode after 20 minutes without operation. The power consumption in standby mode is less than 0.5 Watts.

13. TRADEMARK



The Bluetooth® word mark and logos are registered trademarks owned by Bluetooth SIG, Inc. and any use of such marks by HARMAN International Industries, Incorporated is under license. Other trademarks and trade names are those of their respective owners.



Este produto está homologado pela Anatel, de acordo com os procedimentos regulamentados para avaliação da conformidade de produtos para telecomunicações e atende aos requisitos técnicos aplicados.

Para maiores informações, consulte o site da Anatel – www.anatel.gov.br

Este equipamento não tem direito à proteção contra interferência prejudicial e não pode causar interferência em sistemas devidamente autorizados.

Активная акустическая система

Изготовитель: Харман Интернешнл Индастриз Инкорпорейтед, США, 06901 Коннектикут, г.Стэмфорд, Атлантик Стрит 400, офис 1500

Сделано в Китае

Импортер: ООО "ХАРМАН РУС СиАйЭс", Россия, 127018, г.Москва, ул. Двинцев, д.12, к. 1

Гарантийный период: 1 год

Срок службы: 2 года

Информация о сервисных центрах: www.harman.com/ru

Техническая поддержка: 8 (800) 700 0467

Организация, уполномоченная на принятие претензий потребителей: ООО "ХАРМАН РУС СиАйЭс"

Товар сертифицирован

Дата изготовления устройства определяется по двум буквенным обозначениям из второй группы символов серийного номера изделия, следующих после разделительного знака «-». Кодировка соответствует порядку букв латинского алфавита, начиная с января 2010 года: 000000-МУ0000000, где «М» - месяц производства (А - январь, В - февраль, С - март и т.д.) и «У» - год производства (А - 2010, В - 2011, С - 2012 и т.д.).



HARMAN International Industries,
Incorporated 8500 Balboa Boulevard,
Northridge, CA 91329 USA
www.jbl.com

© 2022 HARMAN International Industries, Incorporated. All rights reserved.
JBL is a trademark of HARMAN International Industries, Incorporated, registered in the United States and/or other countries. Features, specifications and appearance are subject to change without notice.